

Crystal trimming instruction

for: #626PM33SP

#627PM33SP

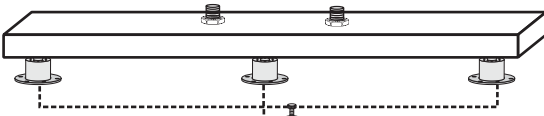

CAUTION RISK OF FIRE
MAX 60 WATTS,
TYPE GU10 LAMP

-Outer layer(Row)
Trim only every other hole
***Not every hole

Pin the enclosed Crystal strands
Randomly to a style that is
pleasing to you. This is no
set pattern for this fixture.

Top View
of the plate

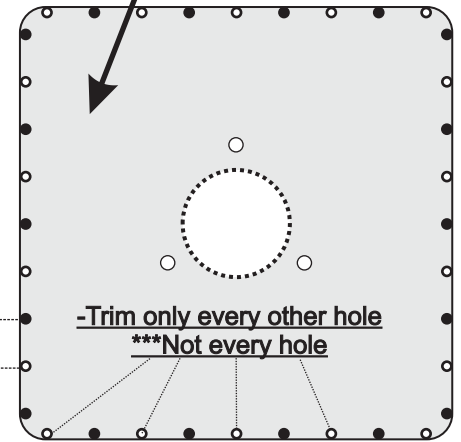
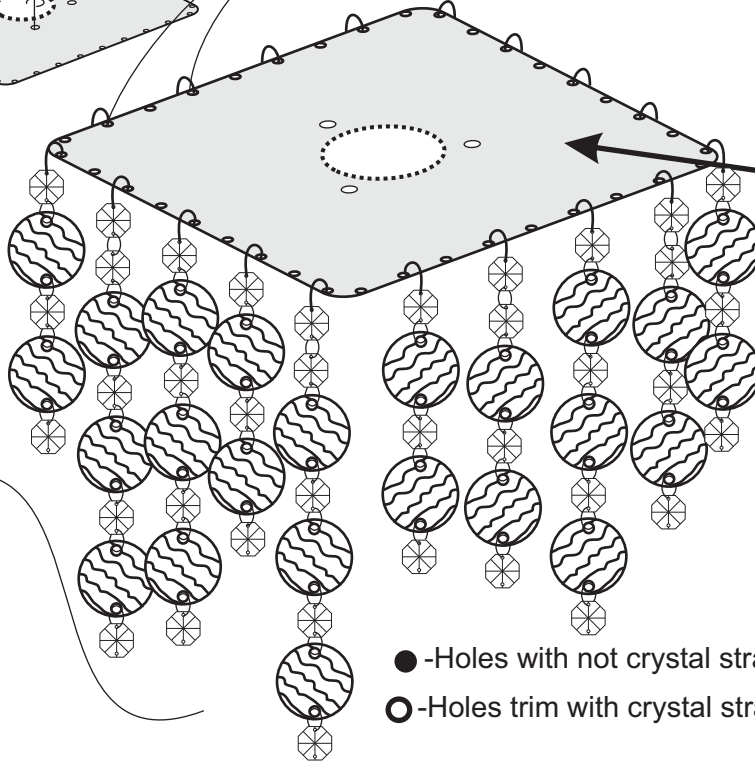

Side
View
of the
plate

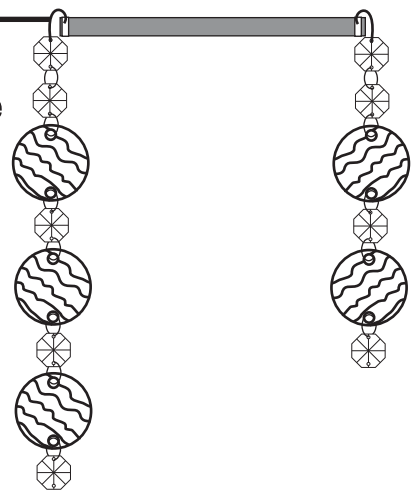

1 package contain
A=4 set
B=6 set
C=5 set
Total =15 strand/pack
Require x 3 package
for this fixture

CARE PACKAGE

Your crystal fixture is packed to include extra pins and crystal pieces for future use. These extra parts may come in handy if a piece or two is chipped or misplaced while the fixture is being untrimmed. As they may be useful in some future days, please store them safely.

Cleaning Instructions

Your fixture requires regular cleaning and, depending on the volume of traffic where your fixture is displayed, the frequency may vary. We recommend the following steps for cleaning.
Caution: When Trimming or Un-trimming your fixture, never attempt to rotate or counter rotate your fixture as it may result in the risk of fire, electric shock, personal injury and property damage. **Caution:** If the fixture is displayed beyond reach, you are advised to have a professional cleaner to perform the cleaning as it may result in the risk of fire, electric shock, personal injury and property damage.

1. Retrieve the copy of Trimming Instructions, packed with the fixture when it was purchased.
2. Study and Identify all the crystal strands from the trimming instructions and the fixture. Please note how the fixture was trimmed originally, the strand "A" was trimmed first. However, when un-trimming the fixture, the order is backwards. With care, remove, starting from the higher alphabetic number first, all the identical strands of crystal, place them aside, and make a note to label these strands of crystal according to the trimming instruction.
3. Continue to un-trim as 2 above until you reach the last strand labeled "A".
4. With a lint-free cloth and some lukewarm water solution, mixed at a ratio of 100 parts water to 1 parts of white vinegar, wipe each of the crystal strands clean until satisfactory.
5. Ensure the power to the fixture is turned off and the light bulbs are cooled down, use a lint-free cloth and ring out dry with some lukewarm water, mixed as 4 above, wipe the fixture clean until satisfactory. **Caution:** ensure no water is dripped into any electrical components as it may result in the risk of fire, electric shock, personal injury and property damage.
6. Re-trim your fixture, starting from the strand "A", until the last strand is complete.



CAUTION: RISK OF ELECTRICAL SHOCK. Make sure the electrical supply to the chandelier is turned off at the main fuse or circuit breaker before doing any installation. **Safety Information: Important!** For your protection and safety, carefully read and understand the information given on this sheet before beginning installation. Failure to do so may lead to fire, electric shock, personal injury and property damage.

Note to electrician:

1. All electrical connections must be in agreement with local codes, ordinances or the national electrical code. This product must be installed in accordance with the applicable installation code by a person familiar with the construction and operation of the product and the hazards involved.
2. Turn off electricity at the main fuse box (or circuit breaker box) before beginning installation by switching circuit breaker off or removing fuse.
3. Do not connect this fixture to a non-grounded electrical system. (See wiring below) Warning: installing this fixture into a non-grounded electrical system could allow metal parts of fixture to carry electrical current if any fixture wires, wire connections or splices become broken or loose. Under this condition, anyone coming in contact with fixture is subject to electrical shock, which could cause injury of death.
4. Do Not suspend any fixture by the house wires. A fixture must always be mounted directly to an outlet box or to a cross bar which is first attached to outlet box. Wire connections will not support the weight of a fixture. Suspending a fixture by the wires will result in the fixture falling, with the possibility of injury and the danger of electrical shock or fire.
5. Be careful not to damage or cut the wire insulation (covering) during installation. Do not permit wires to contact any surface having a sharp edge. Doing so may cause serious injury or death from electrical shock.
6. Do not use lamps (bulbs) having a wattage greater than the maximum value stated on the fixture. Doing so may cause the risk of fire.
7. If a dimmer control switch is used, obtain professional advice for the correct type and electrical rating required.

WIRING AND INSTALLATION

INSTRUCTIONS:
THIS PRODUCT MUST BE INSTALLED IN ACCORDANCE WITH THE APPLICABLE INSTALLATION CODE BY A PERSON FAMILIAR WITH THE CONSTRUCTION AND OPERATION OF THE PRODUCT AND THE HAZARDS INVOLVED (Manufacturer recommends a certified electrician should always be employed for the installation and wiring of the fixture)

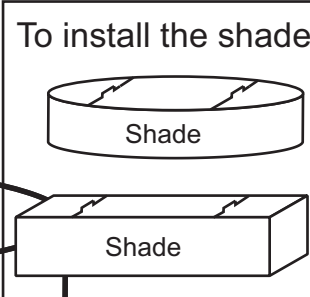
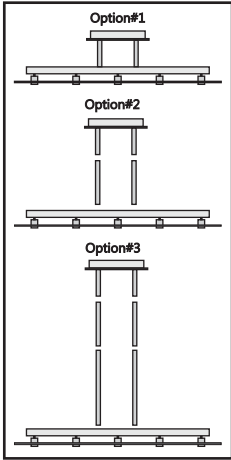
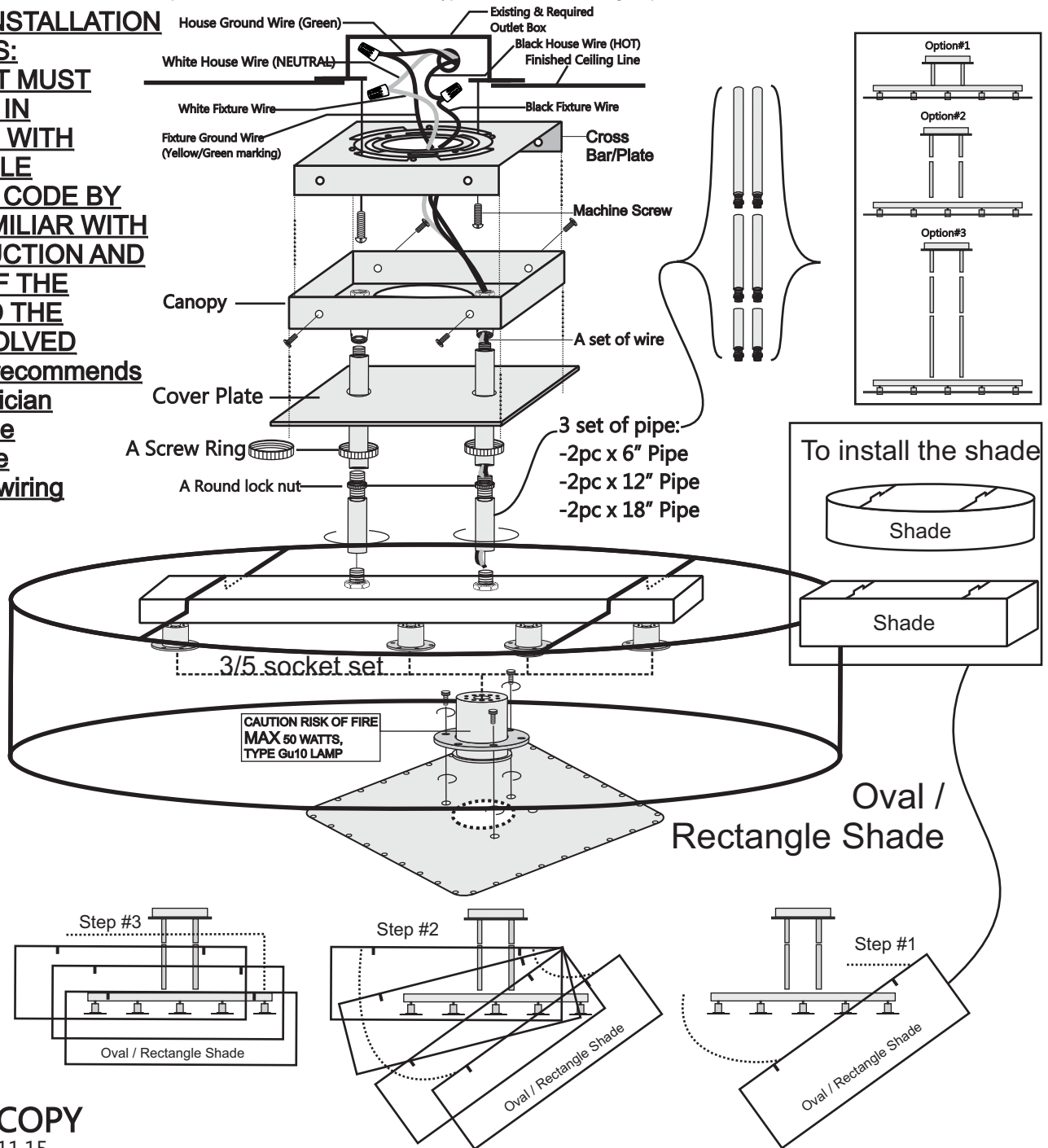

Oval / Rectangle Shade

